

A detailed wireframe rendering of a mechanical component, possibly a rotor or a part of a motor, showing intricate internal structures and a yellow-colored section. The rendering is semi-transparent, revealing the internal gears and components.

KASBER
Safety

2020
Dispositivo autorretráctil

KAPEK

INTERNACIONAL SAC

www.kapekinternacional.com

0

50

100

150

200

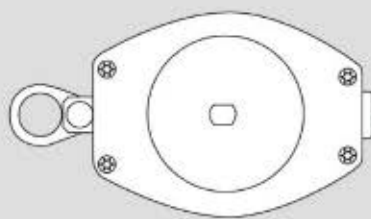

 **ALPHA**

Dispositivo autorretráctil de cincha



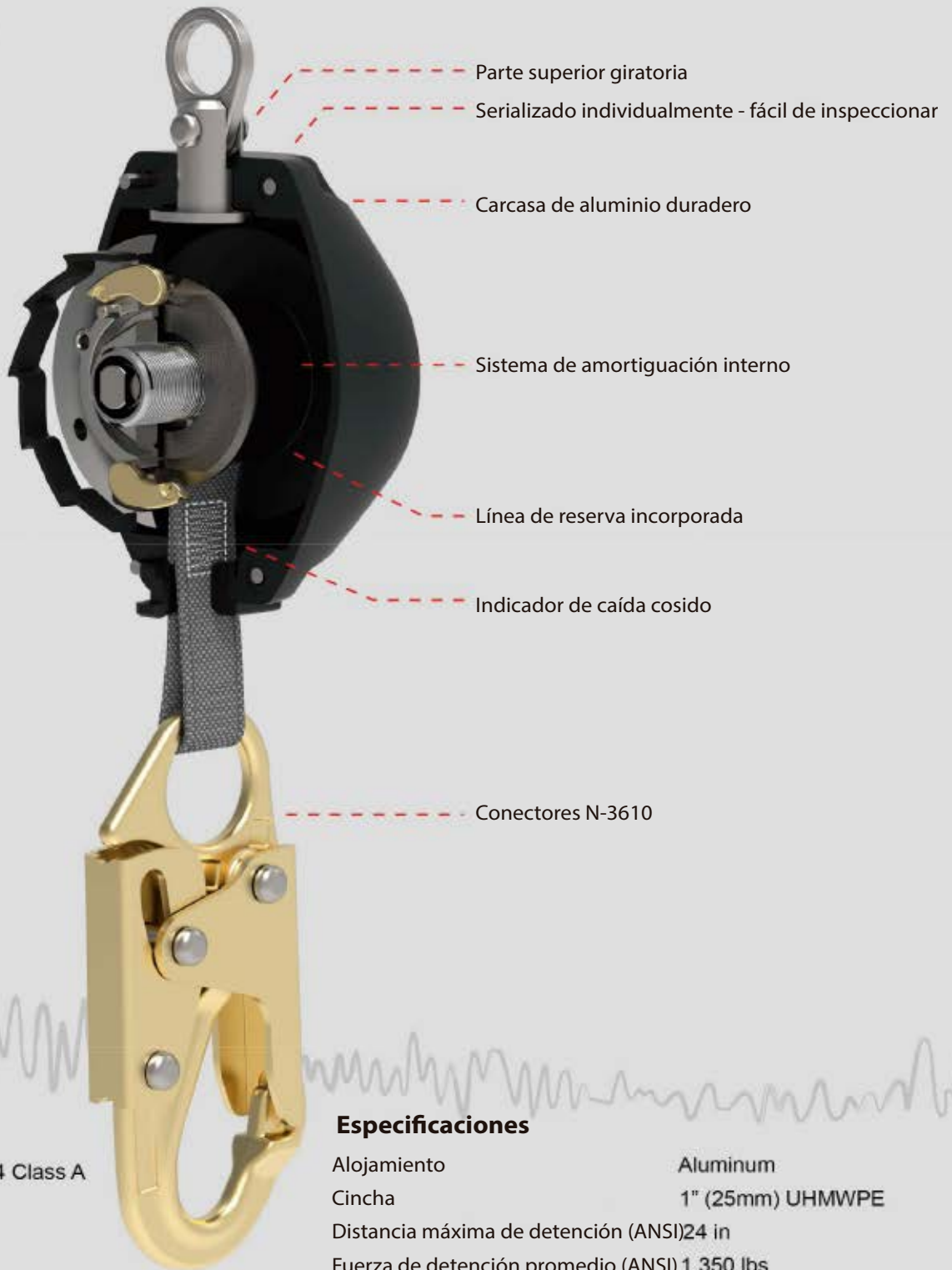

- Parte superior giratoria
- Serializado individualmente - fácil de inspeccionar
- Carcasa de aluminio duradero
- Sistema de amortiguación interno
- Línea de reserva incorporada
- Indicador de caída cosido
- Conectores N-3610

Estándares

ANSI Z359.14-2014 Class A
 CSA Z259.2.2-98
 CE EN360-2002

Especificaciones

Alojamiento	Aluminum
Cincha	1" (25mm) UHMWPE
Distancia máxima de detención (ANSI)	24 in
Fuerza de detención promedio (ANSI)	1,350 lbs
Distancia máxima de detención(EN)	2 M
Fuerza máxima de detención (EN)	6 kN
Capacidad (ANSI)	310 lbs
Capacidad (OSHA)	420 lbs
Capacidad (EN)	140 kgs

Color de la carcasa

● Negro ○ Otras disponibles

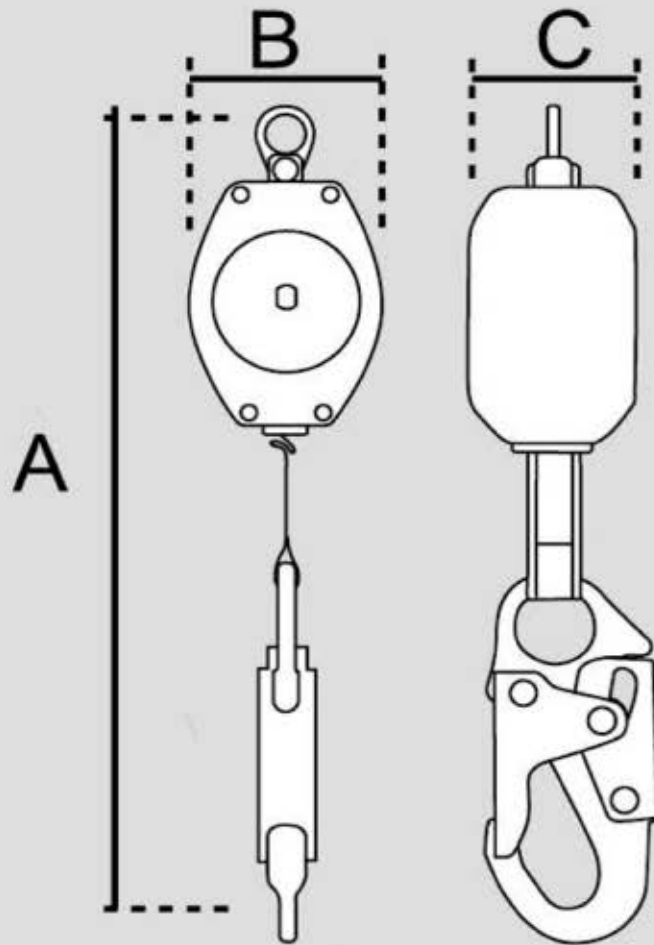

N-331 - SOPORTE DE PATA

		Dimensión pulgadas (mm)	
Parte N°	N-9310-11	A	16.3 (415)
Longitud de trabajo	11 ft / 3M	B	4.1 (105)
Peso	3.6 lbs / 1.7kg	C	3.0 (75)

SRD Soporte de Dos Patas

Parte N° N-331

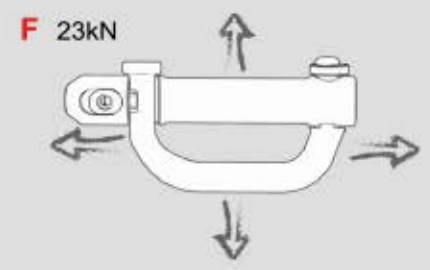
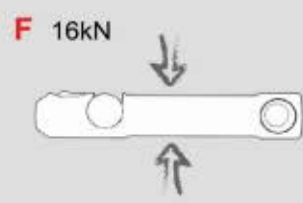
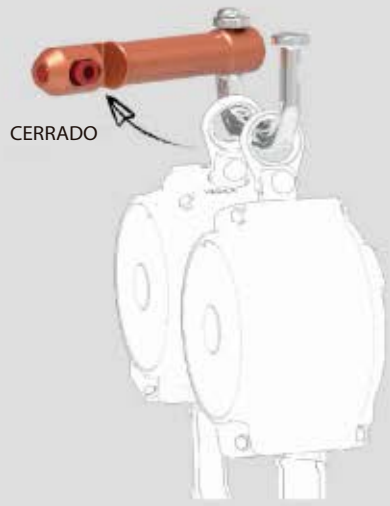
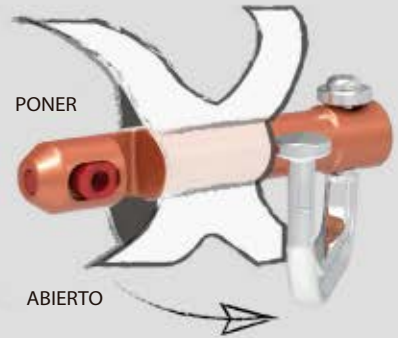

Especificaciones

- Acero forjado
- Aleación de aluminio
- Peso neto
- Zincado/anodizado

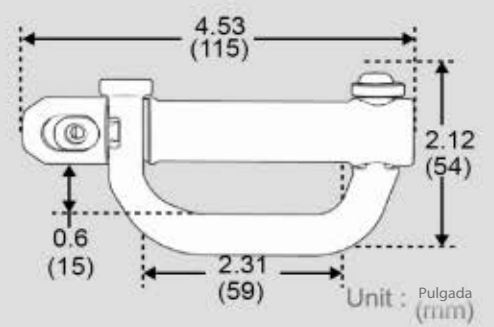

Características

- Doble bloqueo: se requieren 2 acciones separadas para abrir
- Aluminio ligero y duradero
- Facilidad de uso: el usuario puede instalar fácilmente los SRD
- Se adapta de forma flexible a: N9310-11



KASBER
Safety

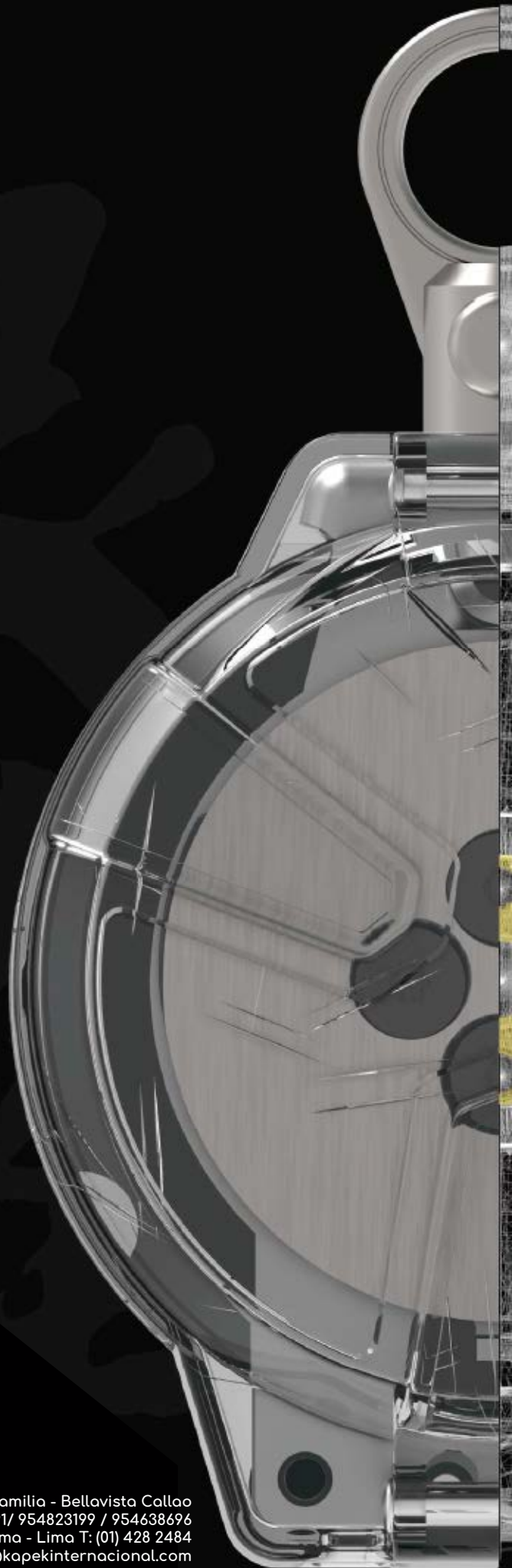

KAPEK
INTERNACIONAL SAC

Calle Las Rosas N° 314 Urb. Sagrada Familia - Bellavista Callao
T: (01) 265 5765 / 962649491/ 954823199 / 954638696
Tienda: Jr. Cotabambas N° 297 - Cercado de Lima - Lima T: (01) 428 2484
ventas@kapekinternacional.com
www.kapekinternacional.com